

Gene Café

Owner's Manual
(Rev. 01)

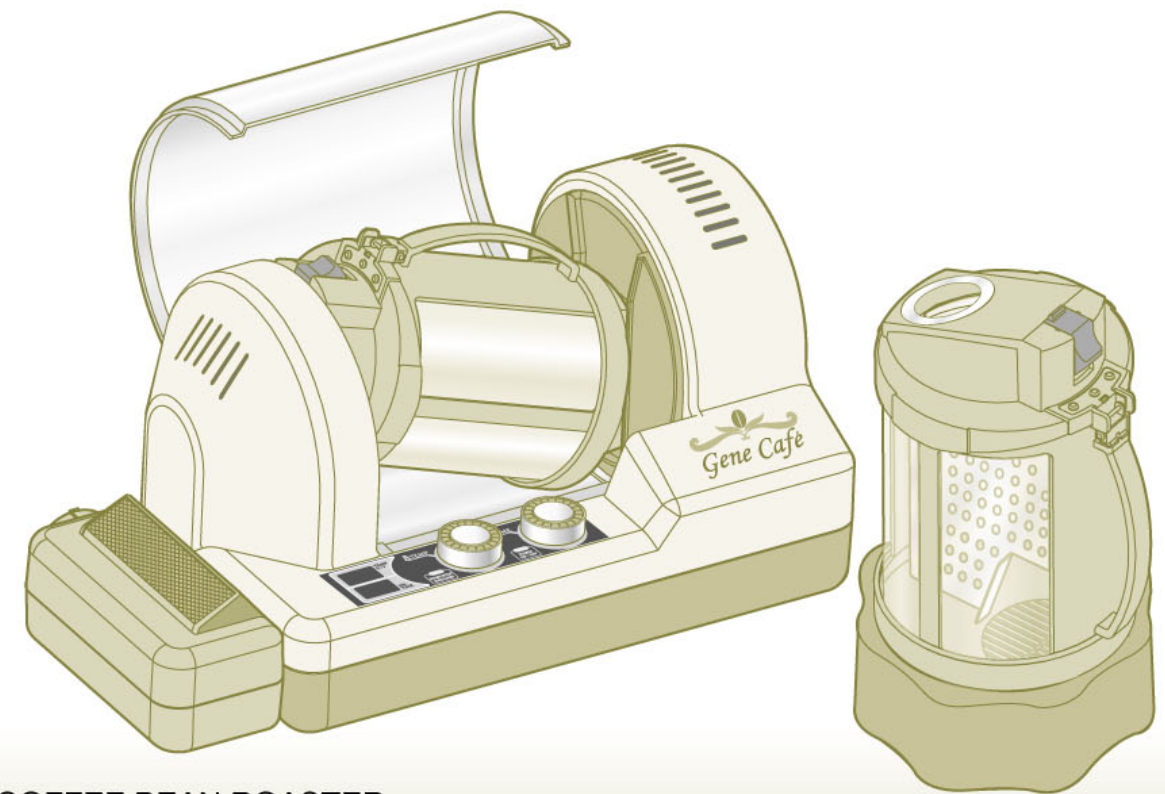

COFFEE BEAN ROASTER
MODEL CBR-101
INNOVATIVE OFF - AXIS ROTATION

- To ensure safe, trouble-free operation, please carefully read this manual
- Warranty information contained in this manual. Do not discard.



Purchase Record	
Product Name :	<i>Gene Café</i>
Model Name :	CBR-101
Date of Purchase :	(mm/dd/yyyy)
Customer name :	
Dealer :	

Gene Café

- Contact the above distributor for warranty or service inquiries.
- Keep this booklet; do not throw it away. Note that the Warranty is not transferable.
- Warranty Period: One year from the purchase date.



When using electrical appliances, basic safety precautions should always be followed, including the follow;

1. Read all instructions.
2. Do not touch hot surfaces. Do not touch moving parts when machine is operating.
3. Roaster will stop automatically if system detects a problem or burnt chaff.
4. Use this roaster in a well-ventilated room, preferably under an exhaust hood.
5. To protect against risk of electrical shock, do not immerse this appliance, including the plug and cord, in water or any other liquid.
6. Roaster should never be allowed to operate unsupervised. It is not a toy and should not be used by children.
7. Always unplug the roaster from its electrical supply when not in use. Allow to cool completely before moving, storing or cleaning this appliance.
8. Do not operate roaster if it has been dropped or damaged in any manner or if roaster is malfunctioning. Return appliance to the nearest authorized service facility for examination, repair or adjustment.
9. The use of accessory attachments not recommended by the manufacturer may cause fire or injuries and may void the product warranty.
10. Do not let cord touch hot surfaces or hang over the edge of the counter or table.
11. Do not place appliance on or near a hot gas or electric burner or in a heated oven.



12. Do not use outdoors.
13. Do not use appliance for any purpose other than roasting coffee beans.
14. Overfilling the roaster, inserting utensils, aluminum foil or metal packages may create a risk of fire or electrical shock.
15. Do not operate roaster close to curtains, draperies, walls or other flammable materials.
16. This appliance has a polarized plug (one blade is wider than the other). To reduce risk of electric shock, this plug is intended to fit into a polarized outlet. If plug will not go into the outlet, reverse the plug. If the plug still does not fit, contact a qualified electrician. Do not attempt to modify the plug in any way.
17. Do not attempt to dislodge trapped beans when roaster is plugged in.
18. Do not operate roaster unattended.
19. Keep pets away from roaster when it is in operation.
20. Do not clean with a metal scouring pad. Metal fragments may enter the roaster's mechanism, and cause electrical shock, damage or fire.
21. Never operate the appliance without the roasting chamber in place.



- Before use, please read the cautions described on pages 15 ~ 17 to use this product safely.
- This manual also contains warranty information. Please save this manual in a safe place.

1. Important Safeguards	1
2. Table of Contents	2-3
3. Introduction	4
4. Features	5
5. Configuration	6
6. Parts Names & Functions	7-8
7. Operation	9-13
a. Preparing to roast coffee	9-10
b. Power supply and timer setting	10
c. Setting and changing the roasting temperature	11
d. Cooling cycle start/stop	12
e. Removing the roasted beans from your roaster	13
8. Roasting Guide	14
9. Safety Precautions	15-17
10. Cleaning and Maintenance	18
11. Troubleshooting	19-20
12. Error Messages and Emergency Procedures	20
13. Notes	21-22
14. Warranty and Purchase Record	Back Cover



Thank you for purchasing the Gene Café CBR-101 coffee bean roasting system.

The Gene Café CBR-101 is designed to be used as a household coffee roaster. It incorporates state-of-the-art design, the highest quality materials and expert workmanship. Genesis technology simplifies and automates the coffee roasting process, making it easy for coffee lovers to produce fresh, great-tasting coffee at home.

Before using the Gene Café, read this manual carefully to learn how to use and maintain your appliance. Save these instructions.

Specifications

Name/Model	<i>Gene Café</i> CBR-101	
Mixing type	Vortex twisting	
Cooling	Ambient temperature forced ventilation (approx. 10 minutes)	
Heating	Indirect hot air (0~30 minutes)	
Temperature Control	0°F - 482°F / 0°C - 250°C	
Heater	1,200 - 1,300 Watts	
Power Supply	110V , 120V, 220V, 230V, 240V - 50/60 Hz	
Power Consumption	1,200- 1,300 Watts	
Chamber	Material	Heat resistant tempered glass tube (Pyrex®)
	Capacity	Max. 10.6 oz / 300g
Noise	65 dB	
Dimensions	19" x10" x9" / 490mm x 243mm x 229mm(Chaff Collector included)	
Weight	12.13 lbs/5.5 kg	
Color	Black	
Optional parts	Large capacity chaff collector(Smoke extension type)	

Design and specifications subject to change without notice.
"Pyrex®" is a registered trademark of Corning Incorporated



4. Features

Removable roasting chamber to make filling, emptying and cleaning easy and convenient.



Removable Chamber

Full range roasting temperature control can produce anything from a light roast to a dark Italian roast that is ideal for espresso.



Automatic Temperature Control

Adjustable roasting timer can accommodate on-the-fly changes without interrupting or restarting the roasting cycle. ■



Automatic Timer

Automatic cool-down cycle prevents residual heat from over-roasting the beans.



Automatic Cool-Down

Overheat protection sensors monitor the system and shut it down in case of overheating.



Overheat Protection

Chaff and escaping gases are circulated away from the beans as they roast, before they can impart an off-taste to the coffee. Chaff is collected in a removable, easy to clean compartment.



High Efficiency Chaff Collector

Off-axis divided rotating chamber ensures efficient and even roasting. Patent pending.



Innovative 3D Agitation

The Gene Café roaster's clean lines and small footprint make it a welcome addition to the kitchen counter.



Sleek Eurostyle Design

Unlike some roasters, the Gene Café has a clear roasting chamber and safety cover that enable you to check the progress of coffee as it is roasting.



Clear Roasting Chamber

A powerful convection fan rapidly circulates heated air through the chamber. To prevent scorching, beans never come into direct contact with the heat source.



Convection Heating

3D agitation and convection heating allow the Gene Café to roast up to 10.6 oz (300g).



Large Capacity Chamber

Superior design and quality construction make the Gene Café blissfully quiet. Outputting only 65 dB, it can be used indoors without creating a disturbance.



Quiet Operation

Our After/Service program is there when you need it, should you experience a problem with your Gene Café coffee roaster.



Convenient Service and Support

5. Configuration



MAIN BODY



CHAMBER

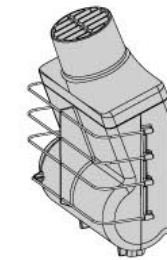

LARGE CAPACITY CHAFF COLLECTOR (Smoke Extension Type)

※ Optional Product

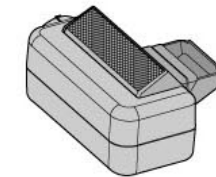

CHAFF COLLECTOR (Standard)

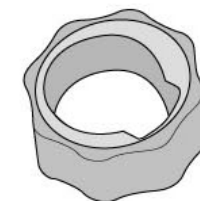

CHAMBER STAND



MEASURING CUP (100g/3.5oz)



OWNER'S MANUAL



6. Parts Names & Functions

6. Parts Names & Functions



Main Body

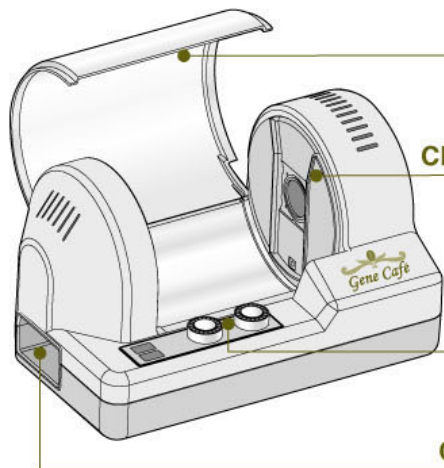

Safety Cover

The clear safety cover helps protect against burns and accidents while still allowing the user to monitor the roasting process. Always close the safety cover before starting the roaster.

Chamber Attachment

The removable roasting chamber easily attaches to the rotating mount, which supplies heated air to the chamber.

Control Panel

Simple fingertip controls make it easy to set roasting time, temperature, cooling cycle and main power on/off.

Chaff Collector Port

The detachable chaff collector attaches to this opening.

Chaff Collector

Chaff Collector As coffee beans roast, the husk-like skin that surrounds the coffee beans dries out and falls off. If left in with the roasted beans, chaff would impart an unpleasant taste to the coffee. When roasting large quantities of beans, especially dry processed varieties, we recommend the optional large capacity chaff collector.

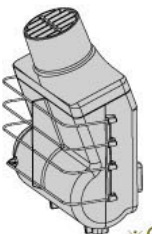
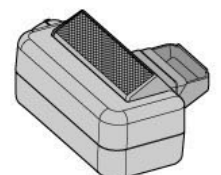
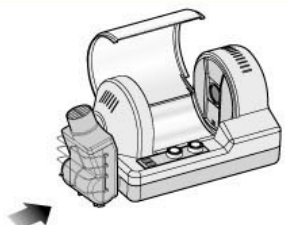
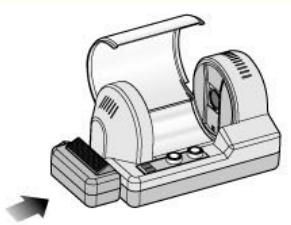
	Large	Standard
CHAFF COLLECTOR	 ※ Optional Product	
ASSEMBLY		

Chamber

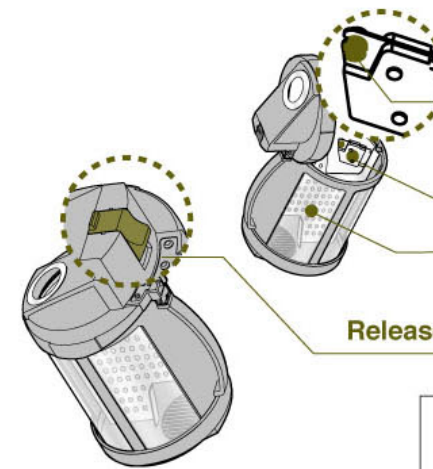

Blade Rubber Reduce the shock of blade.

Blade Aids in removing chaff from the beans.

Separator Dividing the chamber improves mixing efficiency to achieve a more even roast.

Release Button To remove the chamber from the Gene Café roaster, depress the button to release the locking mechanism.

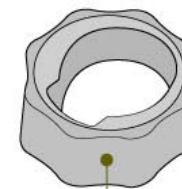
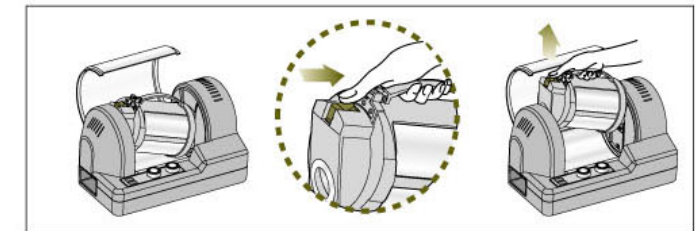

Chamber Stand Supports the chamber in an upright position on your counter to make filling and cleaning easier.



Control Panel

※ For details about operations, refer to pages 11-12 in this manual.

Temperature (Start/Stop) Dial

- (1) Turning the dial to the left decreases the roasting temperature; turning it to the right increases the temperature setting.
- (2) Depressing the dial manually changes from roasting cycle to cooling cycle.
- (3) Holding down the dial manually, changes from cooling cycle to Emergency stop.

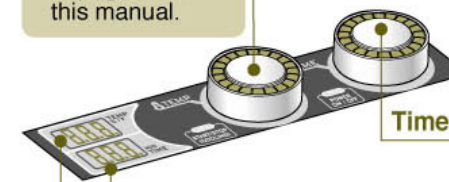

Timer (Power On/Off) Dial

- (1) Turning the dial to the left decreases the roasting time, turning it to the right increases roasting time.
- (2) Depressing the dial turns the main power on or off.

Time Display

Displays the roasting/cooling time

Temperature Display

Displays the roasting/cooling temperature

1 Before Roasting

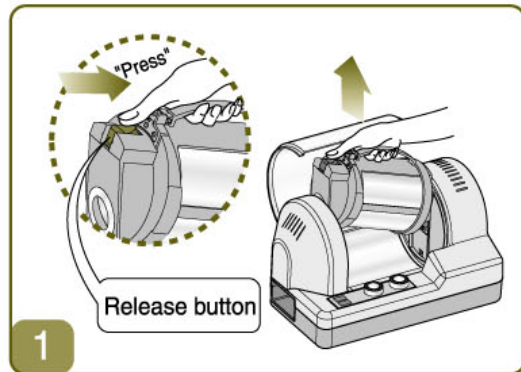

1. Open the safety cover, grasp chamber handle, press release button and lift chamber straight up to remove it from the roaster.

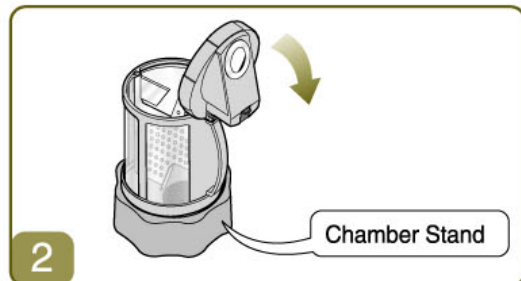

2. Gently place the roasting chamber on the chamber stand and open the lid.

Warning * Always use the chamber stand; do not attempt to stand the chamber upright on a counter; it may tip over and break.

* Use care when reaching inside the roasting chamber; the metal separator has sharp edges.

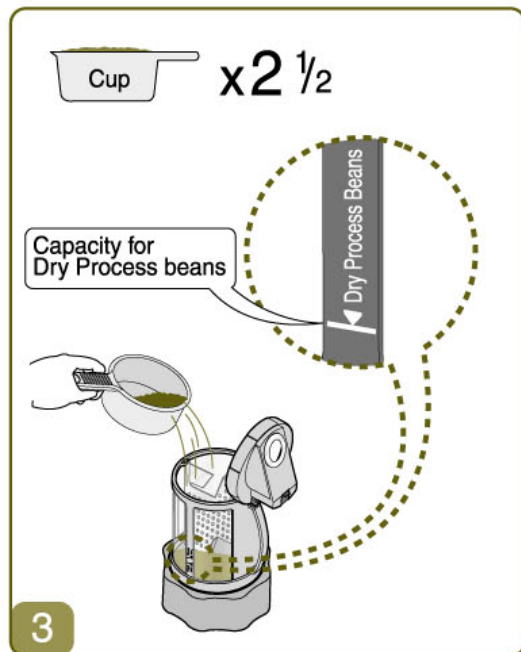

3. Fill the roasting chamber with the desired amount of green coffee beans using the measuring cup. The measuring cup supplied with your Gene Café roaster holds 3.5 oz (100g). Do not exceed the machine's capacity. There is a maximum fill line on the side of the chamber.

Warning * The maximum capacity is 11 oz (300g); exceeding this amount may cause uneven roasting or a fire that could damage the roaster. Be sure not to exceed the maximum amount limit.

* When roasting dry processed or peaberry coffee beans, do not roast more than 8 oz at one time.

* Roasting coffee beans containing impurities or debris may cause a fire. Sort through the beans and remove any foreign material before placing beans in roaster.

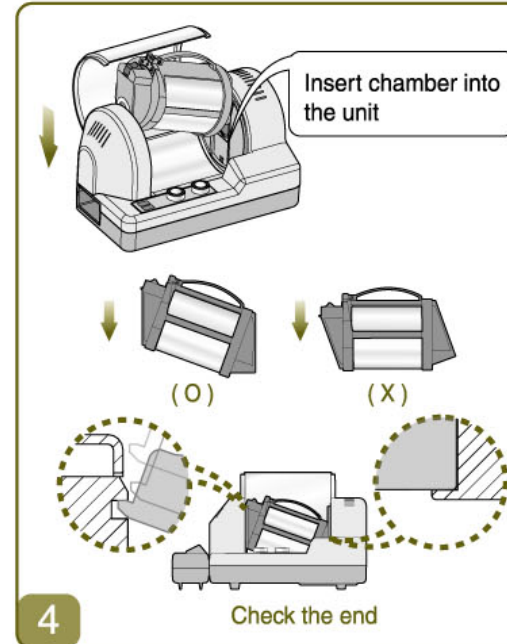

4. Close the roasting chamber cover. With the cover end of the chamber facing to your left, as shown in the figure, align the chamber cover with the groove on the roaster, and gently push the chamber down until it clicks into place. To ensure that the chamber is installed properly, lightly pull up on the chamber handle. The chamber should not move upward.

Warning * When assembling the roasting chamber and body, make sure that the chamber cover faces to the left.

* Failure to ensure that the roasting chamber cover is completely closed, and that the chamber is properly seated in the machine, may result in damage or the machine not working correctly.

5. To ensure safe operation, close the safety cover and attach the chaff collector to the left side of the roaster before starting the machine.

Warning * Remember that the Gene Café should never be operated with the safety cover open. It is dangerous to touch the hot roasting chamber, especially when it is in motion. Never insert foreign objects into the roaster.

* Do not operate the Gene Café without the roasting chamber in place.

* The Gene Café body and surrounding area becomes very hot when the roaster is in operation. Do not leave the unit running unattended, especially if children are present.

* Before operating the roaster, be sure that the chaff collector is clean and properly fitted onto the machine. Do not attempt to attach anything other than the chaff collector to the chaff collector port.

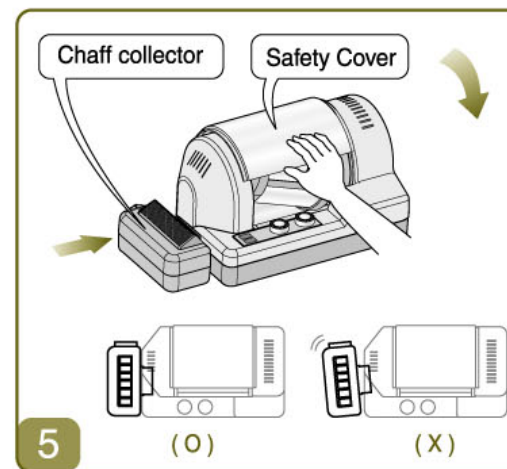

* To ensure safe operation, be sure that you have read this manual and thoroughly understand it. Always remember to observe the following:

- Warning**
- (1) Keep the chaff collector clean, including the mesh screen.
 - (2) Remove any foreign objects from the roasting chamber groove and drum area.
 - (3) Remove any objects that may interfere with the chaff collector port or obstruct the roasting chamber's rotation.
 - (4) Operate the machine in a well-ventilated area, ideally under an exhaust hood.
 - (5) Keep flammable materials well away from the roaster. Restrict access by pets and children.
 - (6) As with all heat generating kitchen appliances, always keep a fire extinguisher nearby.

2 Power Supply and Timer Settings

1. Check the voltage rating printed on the identification plate located on the bottom of the roaster, and connect the Gene Café to the proper power supply.



2. Press **TIME (POWER ON/OFF)** dial to turn on the Gene Café.

- Display shows the temperature and roasting time.
- There will be a two second delay before you can change the settings.
- The chamber executes idle operation once.

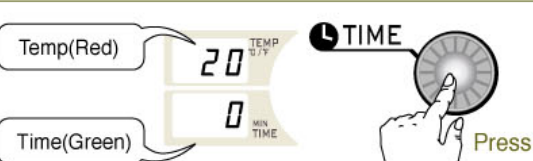

3. Set the roasting time by turning the **TIME (POWER ON/OFF)** dial to the right.

- Refer to the Roasting Guide on page 14 for recommended roasting time.
- Turning the dial from zero displays 15 minutes for the first operation time.
- For precise control, you can set the timer at intervals of six seconds, within a total roasting range of between 0 and 30 minutes.

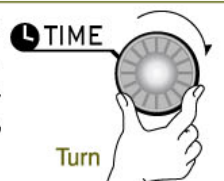

3 Temperature Setting and Roasting

1. Turn the **TEMP (START/STOP)** dial to the right to set the desired temperature

- Refer to the Roasting Guide on page 14 to obtain the recommended roasting temperature.
- Temperature can be controlled in one-degree increments between 0 - 482°F/0 - 250°C.

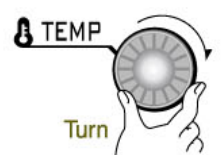

2. After setting the temperature, press the **TEMP (START/STOP)** dial to begin the roasting process.

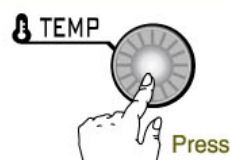

3. To extend the roasting time if necessary, turn the **TIME (POWER ON/OFF)** dial to the right.

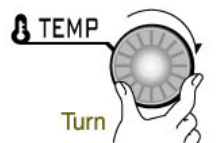

Cooling Start/Stop 4

1. Once the roasting time has elapsed, the Gene Café will automatically begin the cooling cycle. The cooling cycle ends, and the roaster emits an audible signal when the roasting chamber safely reaches 140° F/60° C.

2. Manual Roasting Stop: To stop the roasting process and begin cooling the beans, regardless of remaining roasting time.

- Press **TEMP (START/STOP)** dial while the Gene Café is in the roasting cycle.

- Gene Café will immediately start cooling the beans. The cooling cycle will end when the roasting chamber safely reaches 140° F/60°C.

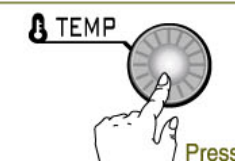

3. Manual Cooling Stop: To interrupt the cooling cycle.

- Press **TEMP (START/STOP)** during cooling cycle.

- Gene Café will continue to cool the beans but will do so only until the roasting chamber temperature reaches its secondary safety level of 212°F/100°C. Time display will display Stp.

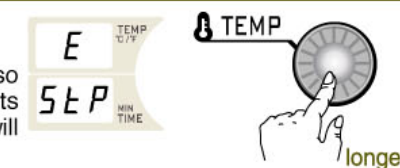

4. Immediate/Emergency Stop

- Press **TEMP (START/STOP)** dial and hold down for at least 2 seconds during the roasting operation.

- Temperature display shows E and time display reads Stp.
- Gene Café immediately stops operating. However, a cooling fan will continue to run until the roasting chamber reaches a safe temperature.

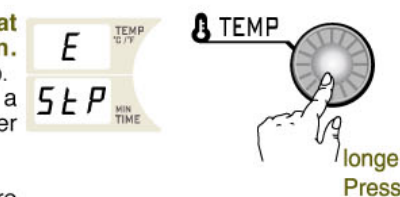

Warning * Allow at least one hour for system to cool, before roasting a second [DMD4]batch.

5. Continuous Roasting

- Roasting once → Immediate stop → Pressing TEMP(STOP) knob → Returning to the default setting(a cooling fan stops)
- After the temperature and timer are set again, it starts operation by pressing TEMP(START) knob

* The above function is usually designed for restaurant, so it is rarely used in home.

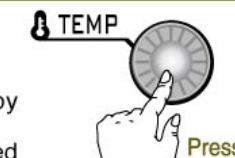

Information displayed during roasting

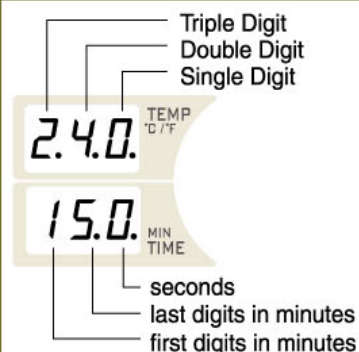

Temperature display alternately shows the current roasting temperature for two seconds, and then displays the set temperature for one second. This cycle repeats for the duration of the process.

Time display shows the time remaining during the roasting cycle, and the elapsed time, starting at zero, for the cooling cycle.

Set the timer at interval of six seconds.

5 Finishing the Roast

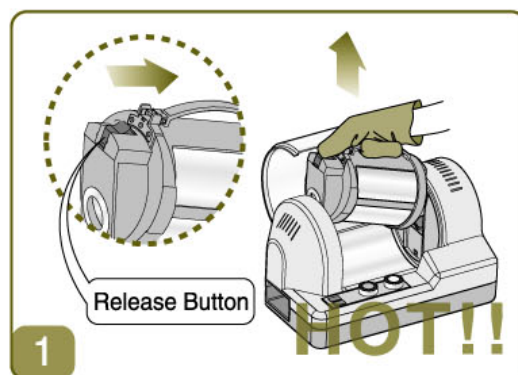

1. When the cooling cycle is completed, the roasting chamber will stop rotating and an audible tone will signal the end of the roasting/cooling process. Raise the safety cover, press the release button and remove the roasting chamber from the roaster by lifting up on the roasting chamber handle.

Warning * Since the chamber may still be hot even after the cooling cycle is completed, use heatproof oven mitts, gloves or a potholder to prevent skin burns when removing the roasting chamber from the Gene Café.



2. Open the roasting chamber cover and pour the roasted coffee beans into a colander, large strainer, cooling rack or large flat plate. Distribute the beans evenly in a single layer to accelerate the cooling process. Beans should be at room temperature before they are ground for brewing. A small electric fan aimed at the beans will accelerate the cooling process.

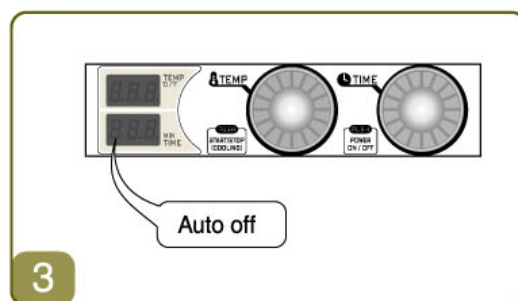

3. Your Gene Café roaster is equipped with an automatic power off function. When the roaster completes its cooling cycle, and the audible tone is heard, the unit goes into standby mode. One minute after the roaster stops, a second audible tone will be heard and the Gene Café will power down as an additional safety measure as well as to conserve electricity.

Warning * When assembling the roasting chamber and body, make sure that the chamber cover faces to the left.

* Failure to ensure that the roasting chamber cover is completely closed, and that the chamber is properly seated in the machine, may result in damage or the machine not working correctly.

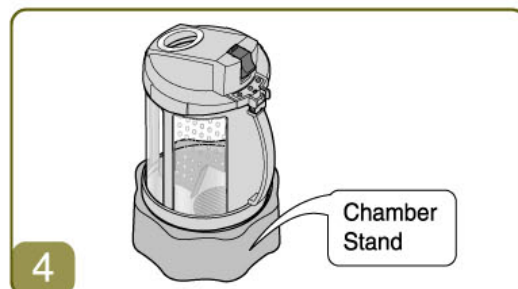

4. Clean the empty roasting chamber as described on page 18, and place it on the chamber stand to dry.

About Coffee Roasting

Green unroasted beans have a very grassy fragrance and are essentially devoid of the flavor that we associate with coffee. Green coffee beans can last for several years when stored in a cool, dry place. Roasting the beans for between 12 and 23 minutes at a temperature of 392° - 482°F (200° - 250°C), develops the characteristic flavors that we associate with brewed coffee. During the roasting process, several changes take place to create a familiar coffee taste. As the beans start to turn brown, water content drops from 10% to 1%; fat increases from 12% to 16%; sugar decreases from 10% to 2%; chlorogenic acid is reduced from 7% to 4.5% and trigonellin lowers from 1% to 0.5%. Caffeine, cellulose, pectin and ash remain unchanged but the physical volume of the bean increase from 1.5 to 2.0 times while the bean's weight drops by 20%. As roasting time is increased, acidity is reduced and bitter notes become more pronounced. There are eight levels of roasting characteristics commonly associated with coffee.

Roasting Levels*

Roasting Level	Approximate Time*	Actual Temperature	Characteristics
Light Roast	12 minutes	446°F (230°C)	Strong acid, yellowish-brown color. Slight grain smell. Weak flavor
Cinnamon Roast	13 minutes	455°F (235°C)	American style. Slightly acidic. Cinnamon color.
Medium Roast	14 minutes	455°F (240°C)	Acidic characteristics and sweet flavors. Nut-like color. American style.
High Roast	15 minutes	464°F (245°C)	Bitter notes more pronounced than acid. Good for iced coffee.
City Roast	17 minutes	482°F (250°C)	Standard well-balanced taste and flavor. New York City origin.
Full City Roast	19 minutes	482°F (250°C)	Bitter characteristic slightly more assertive than acidity. Good for iced coffee.
French Roast	21 minutes	482°F (250°C)	Pronounced bitter notes; rich unique taste. European style. Good for iced coffee.
Italian Roast	23 minutes	482°F (250°C)	Strong and bitter but not acidic. Almost black in color. Good for espresso or cappuccino.

* Times given for roasting stages may vary depending on the type of green beans being roasted, household voltage and other variables





9. Safety Precautions

*** Please read the following information carefully before use.**

Always follow safety precautions when operating your Gene Café roaster. Save these instructions. Incorrect use of an electrical appliance may result in risk of electric shock or serious injuries as well as damage to the appliance.

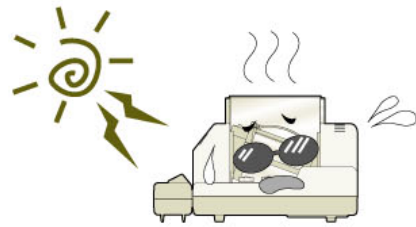
Warning  **Warning : it represents that it may cause serious injuries or even death unless kept.**



Warning  *** To prevent damage, never use or store the Gene Café where it will be exposed to direct sunlight or other heating sources.**



Warning  *** Always use the Gene Café roaster on a level and stable surface.**



Warning  *** Do not immerse the Gene Café in water and do not allow water or cleaning liquids to enter the appliance. Water and other liquids may create a safety hazard or damage the appliance.**

*** Never operate the Gene Café in a sink or wet environment. Doing so may cause electric shock.**

*** If water should penetrate into the Gene Café, disconnect it from the power supply and contact Customer Service.**



Warning  *** Never operate the Gene Café near flammable substances such as oil, alcohol, benzene, gasoline or paint thinner; a fire or explosion could occur.**

*** Do not use the Gene Café in a dusty environment or near flammable materials.**

9. Safety Precautions

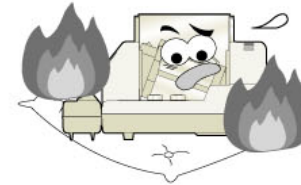

Warning  *** Do not place Gene Café on a pad, cushion or electric blanket as a fire may result.**

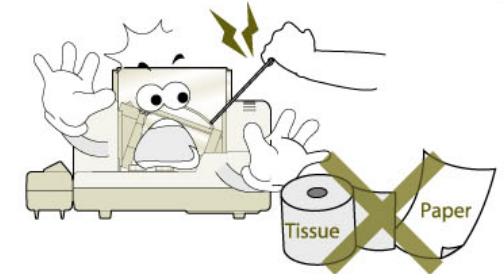

Warning  *** Do not insert foreign objects, especially metal, into the Gene Café as this may create a shock hazard.**

*** Be sure that the Gene Café's air intake holes and the chaff collector exhaust vent are not obstructed. If blocked, overheating and a fire could occur.**

*** If a foreign object accidentally enters the Gene Café, immediately unplug the appliance. Contact Customer Service if the foreign object is lodged inside the unit; do not attempt to disassemble the Gene Café.**

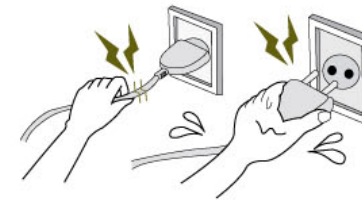

Warning  *** To prevent short circuit, do not bend or force the power plug and do not knot the cord or disconnect the appliance from the wall outlet by pulling on the cord.**

*** Dry hands thoroughly before handling the power cord or operating the Gene Café.**

*** When not in use, disconnect the Gene Café from the power source.**

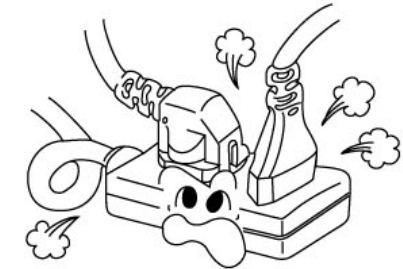

Warning  *** The Gene Café should only be connected to a grounded, properly rated electrical outlet. Overloading a circuit may cause a fire.**

*** If an extension cord must be used, be sure that it is a heavy-duty type with a rating at least equal to the power rating of the Gene Café.**

*** If the power cord of your Gene Café becomes damaged, do not operate the appliance. Contact Customer Service or bring the unit to a professional appliance repair service to have the cord replaced.**

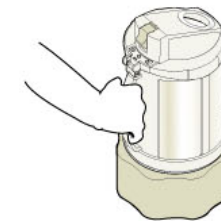

Warning  *** Whenever the roasting chamber is not mounted in the Gene Café, place it in the chamber stand to reduce risk of tipping and breaking.**

*** The roasting chamber is not designed to stand upright without the aid of the chamber stand.**



9. Safety Precautions



Warning * Be sure to close the safety cover during operation to prevent accidental burns. Place the Gene Café out of the reach of children and pets.

* The Gene Café becomes hot during operation, especially the chaff collector exhaust vent. To reduce risk of burns, do not touch the unit during or immediately after operation.

* Always lower the safety cover during operation and do not attempt to reach into the roasting chamber area while the drum is rotating.



HOT!!

Warning * The Gene Café body and roasting chamber may become very hot. Use oven mitts, or a potholder to handle the roasting chamber and do not touch it with bare hands.

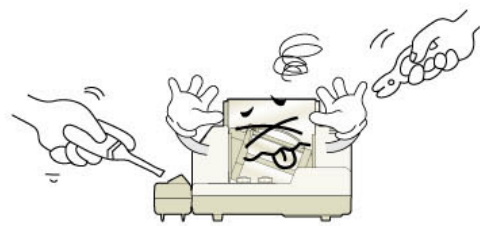

Warning * In case of malfunction, consult the Troubleshooting section of this manual. See pages 19-20. If you cannot resolve the problem, contact Customer Service.

* Do not attempt to disassemble or modify the Gene Café roaster; doing so may create a fire or shock hazard.

* Repairs should only be performed by a qualified service technician.



Warning * To prevent damage or safety issues, do not apply excessive pressure to the Gene Café or drop the appliance.



Warning * Do not attempt to remove the roasting chamber blade or separator; they are permanently attached and help to remove chaff from the roasting chamber where an excessive accumulation may cause a fire.

* Do not attempt to modify the roasting chamber blade or the separator grate.

10. Cleaning & Maintenance



Roasting Chamber



Oils and residual debris remaining from the roasting process will build up and adversely affect the taste of future roasted bean batches. Clean the chamber using a dishwashing brush, sponge and dishwashing liquid. Dry the chamber completely before storing it away.

Chaff Collector & Fan

After each batch, clean the chamber to prevent chaff build-up and the possibility of a fire. Keeping the chaff collector clean helps the Gene Café to operate more efficiently and reduces the amount of smoke and odor produced during the roasting process.

1. The interior screen and exterior mesh plate should be cleaned with a dishwashing brush.

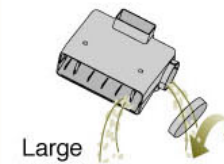

Use a dishwashing brush to clean the outside mesh plate and inside screens on the chaff collector.

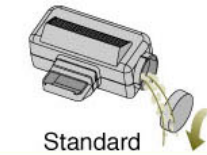

Remember to clean the interior screen on the standard chaff collector.

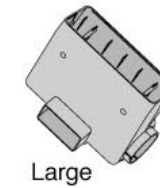

Large

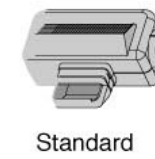

Standard

2. Detach the chaff collector from the Gene Café roaster body by gently pulling it straight away. Rotate the chaff collector cap to the left to remove it, and discard the chaff.



3. Use a dishwashing brush to clean the outside mesh plate and inside screens on the chaff collector



4. Empty and clean the chaff collector after every use and allow it to dry thoroughly before storing.

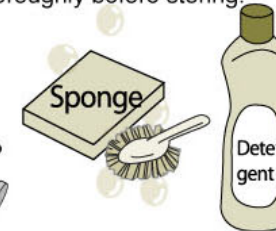

Note * When cleaning the Gene Café, be aware of sharp edges that may cause a cut.

* Never place the Gene Café roaster, roasting chamber, chaff collector or optional accessories in the dishwasher.



5. Remember to clean the mesh net at the bottom side of unit in every 2 months.



11. Troubleshooting

12. Troubleshooting & Error Messages



This troubleshooting guide can be used to diagnose common issues. If your problem is not covered here or cannot be resolved, contact Customer Service.

Symptom	Potential Causes	Corrective Measures	Remarks
Unit does not work.	<ol style="list-style-type: none"> 1. Power cable not connected. 2. Blown fuse or tripped circuit breaker. 	<ol style="list-style-type: none"> 1. Connect the power cable to the outlet. 2. Replace fuse or reset circuit breaker. 3. Try another outlet on a different circuit that is known to be functioning. 4. Review instruction manual for proper operating procedure. 5. Press TEMP (START/STOP) dial. 6. Set the timer. 	
Raw coffee beans are not roasted. Actual temperature never reaches the level of the desired temperature.	<ol style="list-style-type: none"> 1. Unit is connected to a circuit delivering less voltage than required. 2. Roasting chamber was overfilled. 3. Improper roast level settings (time and/or temperature). 4. Chaff collector is clogged. 5. Fan filter is blocked. 6. Another appliance connected to the same circuit, is in operation. 	<ol style="list-style-type: none"> 1. Check rated voltage. Try using another circuit. 2. Follow instructions for maximum amount of green coffee beans. 3. Check and adjust roasting temperature if necessary. 4. Increase roasting time. 5. Clean the fan intake ports on the top of the roaster using a vacuum cleaner fitted with a brush attachment. 6. Turn off any other appliances connected to the same circuit, especially devices that have heating elements in them. 	
Excessive smoke generated during roasting process.	<ol style="list-style-type: none"> 1. Chaff collector screen and/or exterior mesh plate are clogged. 2. Incorrect roasting temperature selected. 3. Roasting chamber overfilled. 	<ol style="list-style-type: none"> 1. Empty the chaff collector. 2. Clean the chaff collector's internal screen and exterior mesh plate. 3. Check temperature and time settings to prevent over-roasting. 4. Use correct amount of green coffee beans. 	Maximum roasting amount per patch is 10.6 oz (300g).
Vents blocked.	<ol style="list-style-type: none"> 1. Roasting chamber overfilled. 2. Lower quality or air cleaned beans generating excess chaff and debris. 	<ol style="list-style-type: none"> 1. Use proper amount of green coffee beans. 2. If green coffee beans have thick skin, roast in smaller quantities. 	
Cannot detach or remove roasting chamber.	<ol style="list-style-type: none"> 1. Release button not fully depressed. 	Fully depress release button while lifting roasting chamber out of the roaster.	
Unable to insert roasting chamber into the Gene Café body.	<ol style="list-style-type: none"> 1. Roasting chamber is being incorrectly inserted into the body. 	<ol style="list-style-type: none"> 1. Be sure that the opening end of the chamber is facing to the left (chaff collector side) of the unit and that the roasting chamber lid is fully closed. 2. Check to see that the roasting chamber is properly aligned with the groove on the left side of the body. 	
Operation (rotation) does not stop.	<ol style="list-style-type: none"> 1. Unit is not cooling down. 	<ol style="list-style-type: none"> 1. The Gene Café will not stop until the unit reaches a safe temperature. 2. Depress TEMP (START/STOP) dial, which will stop the unit when it reaches 212°F (100°C). 	Safety auto stop setting is 140° F (60°C). Intermediate safety stop temperature is 212°F (100°C).

Error Messages & Description

Error Message	E1	E3	E4
Remarks	Temperature sensor 1 error	Irregular rotation. Reed sensor error.	Heater disconnection. Fan or temperature sensor 2 error.

* Contact to the Distributor at the backover if the above message at the view panel.

Emergent Measures

■ In the event that the Gene Café is turned off by mistake.

Immediately turn the unit back on and resume roasting or manually activate the cooling cycle and remove the roasting chamber when it stops in the proper position. If the chamber does not orient to the proper position, do not attempt to forcibly remove it.

■ In the event that a power failure interrupts the roasting process.

If an unexpected power interruption shuts the unit down during roasting, the very hot beans may cause a fire and/or burn injuries. Move the roaster to a safe place and allow it to cool down. Use extreme caution when moving the hot appliance, and wear protective oven mitts.

■ In case of a fire

The extremely high temperatures inside the roasting chamber may cause the skins or chaff to ignite. Remain calm and take the following steps:

* Fire in roasting chamber

1. Press the TEMP (START/STOP) dial to stop the rotation.
2. Protect your hands with oven mitts, carefully remove the chamber and pour burning contents into the sink.

* Fire in the chaff collector

1. Smoldering skins or chaff in the chaff collector will burn out on their own. Allow chaff collector to cool completely before attempting to remove it from the roaster for cleaning.

